

Installation Instructions

4 Sensor BilgAlarm™ Fail-Safe System

Model No. BA4FS-2W12V

The following parts are enclosed:

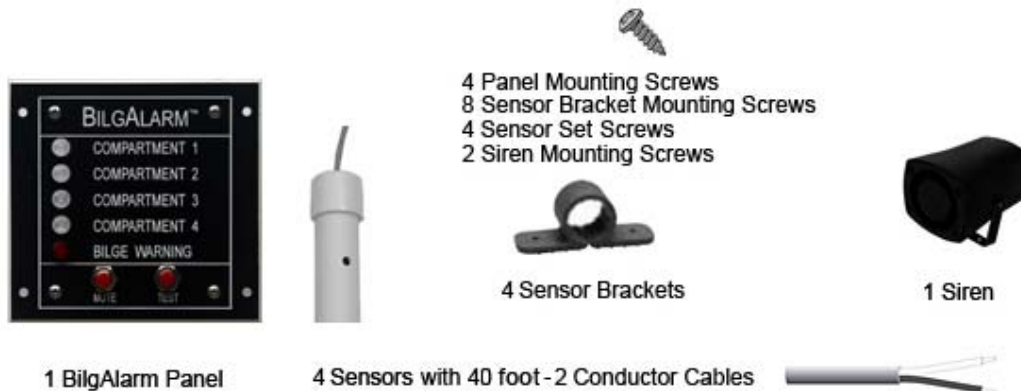

*The most common installation screws are included. Since each installation is different and may require different types and lengths of wood screws, machine screws, washers, lock washers, and nuts, please purchase the screws that are applicable for your installation at your local marine store. Stainless steel screws are recommended.

STEP 1

Mount Control Panel, Sensors, and Siren

Control Panel

Carefully cut a rectangular hole (width) 3.0 inches X (height) 3.3 inches to mount the BilgAlarm™ Control Panel. Inspect carefully behind where you intend to cut to avoid damage to other equipment and provide adequate room for installation of the BilgAlarm™ Control Panel and wiring. Do not cut the hole larger than 3.0 inches X 3.3 inches. The thickness of the mounting surface must not be more than $\frac{3}{4}$ inch. Secure the BilgAlarm™ Control Panel with 4 screws after electrical connections have been made.

Sensors

BilgAlarm™ Sensors are placed vertically (cable end up) where water collects, which is usually where the bilge pumps are located. Place a BilgAlarm™ Sensor 2 to 3 inches above the bilge water level at which the bilge pump normally turns on. Should the pump not turn on or is unable to handle the volume of water coming in, the BilgAlarm™ system will sound an early warning alarm. Repeat installation of the remaining BilgAlarm™ Sensors and run sensor cables back to the BilgAlarm™ Control Panel. Special mounting brackets and mounting screws are provided to attach the sensors. A set screw is provided to secure the sensor to the mounting bracket and to adjust sensor height, if desired. Screw the set screw through any side of the sensor bracket until the sensor is secure.













Siren

Mount the warning siren near the control panel in an unobstructed location. Run the leads back to the BilgAlarm™ Control Panel. Siren leads may be extended, as required.

STEP 2

Wire Sensors, Siren to the Control Panel

Model BA4FS-2W12V

11		Red	Sensor 1
12		Black	
21		Red	Sensor 2
22		Black	
31		Red	Sensor 3
32		Black	
41		Red	Sensor 4
42		Black	
+		Red	Siren
-		Black	
+		Power	12 VDC
-		Power	

Sensors

Attach the two leads of each sensor to the appropriate sensor terminal strip. The terminals are marked for each sensor. See wiring diagram to the left. Be sure to put the proper color wire in the proper terminal strip hole. Tighten securely, but do not over tighten.

Siren

Attach the two leads of the siren to the control panel paying attention to polarity. See wiring diagram to the left. Be sure to connect the red and black wires correctly. Tighten securely, but do not over tighten.

Note: Additional sirens and an optional strobe light may also be added, as long as the total load does not exceed the BilgAlarm™ two ampere (2 AMP) rated output.

Strobe Light (Optional)

Attach the two leads of the strobe light to the siren terminals on the control panel, paying attention to polarity. Connect the negative lead (black) to - and the positive lead (red) to + on the siren output terminal strip. The strobe light will turn off if the siren is muted, but the bilge warning light will continue to flash until all bilge warnings have been corrected.

STEP 3

Connecting Power to the Control Panel & Testing System

Attach power leads (12VDC)

Attach the power leads to the control panel, paying attention to polarity. See wiring diagram above. When power is first applied, the siren will sound for five seconds. You may press the **Mute** button to silence the siren.

Test your system

Test your system now by pressing and holding the **Test** button and then pressing the **Mute** button after the siren turns on. To reset the mute condition, just release the **Test** button and the alarm will reset when the bilge warning light turns off after 5 seconds. You can also test your system by putting a cup of water under a sensor or just placing a wet rag across the sensor electrodes.

To test silently

Press and hold the **Mute** button before depressing the **Test** button. The only sound will be a brief “chirp” when the alarm resets. This completes the installation of your new BilgAlarm™ Early Warning System.

Operating Notes:

The BilgAlarm™ fail-safe, high bilge water warning system is designed to minimize “nuisance alarms” from splashing and sloshing/slopping bilge water in commercial fishing boats and other commercial vessels. Water must be continuously present at a sensor for five seconds for the siren to sound. Conversely, water must be absent from all sensors for five seconds for the **Mute** button to reset. A **RED LED** alarm indicates high bilge water or a shorted sensor cable. A **GREEN LED** alarm indicates an open sensor cable. All alarm systems should be periodically tested to assure that they're functional and that power is present to the system.

To the Installer:

Below is some additional information you may find useful:

Sensors

Each sensor comes with a 40 foot cable. You may shorten it. If you would prefer a longer length, please contact our office. For reliability and longevity of the system, please don't make splices in the sensor cables, especially within the bilge area.

Sensor Installation

Sometimes it's easier to add a pull line through a span that's hard to run cables/wires. A pull line is a line that's twice as long as the span, so you can pull wires in either direction without losing the ends of the line. Secure the ends of the line so they can't be pulled through accidentally. When the task is accomplished, leave the line for the next cable pull. (Nylon clothesline works well)

Splicing Wire

We offer continuous sensor cables to 1000 feet. If splicing of any wires is needed, it's best to take the time and solder the splices and then heat shrink wrap the connections or use specialized water-proof type connectors, or heat shrink crimp connectors. If an improperly wrapped sensor cable splice becomes wet, it will act as a BilgAlarm™ sensor and will also set-off an alarm. BilgAlarm™ is not liable for any sensor cable that has been spliced, altered, or changed.